

ZERO•NET™ FW2500

FIXED WINDOW

PRODUCT DESCRIPTION

The **Zero•Net™ FW2500 fixed window** (also known as picture window) aligns with current trends towards larger punched openings with more glass, letting in more light without compromising on performance.

PRODUCT FEATURES

- Low to high-rise application
- Field or shop glazed
- Incorporates FreMarq's FortMax™ thermal barrier for the highest performance in the industry
- Industry-leading U-values (0.18-0.29) based on NFRC gateway sizes
- Frame CRF 82 based on AAMA 1503-09 testing
- System depth - 5 1/2"
- 2 1/2" mullion sightlines
- Can accommodate infills up to 1 3/4" for greater thermal performance
- Furnished in captured or SSG
- 15 psf static and dynamic water resistance
- Exterior sunshades and interior light shelves available

For additional information (CAD details, specifications, test reports, thermal simulations) visit our website at:

www.fremarqinnovations.com

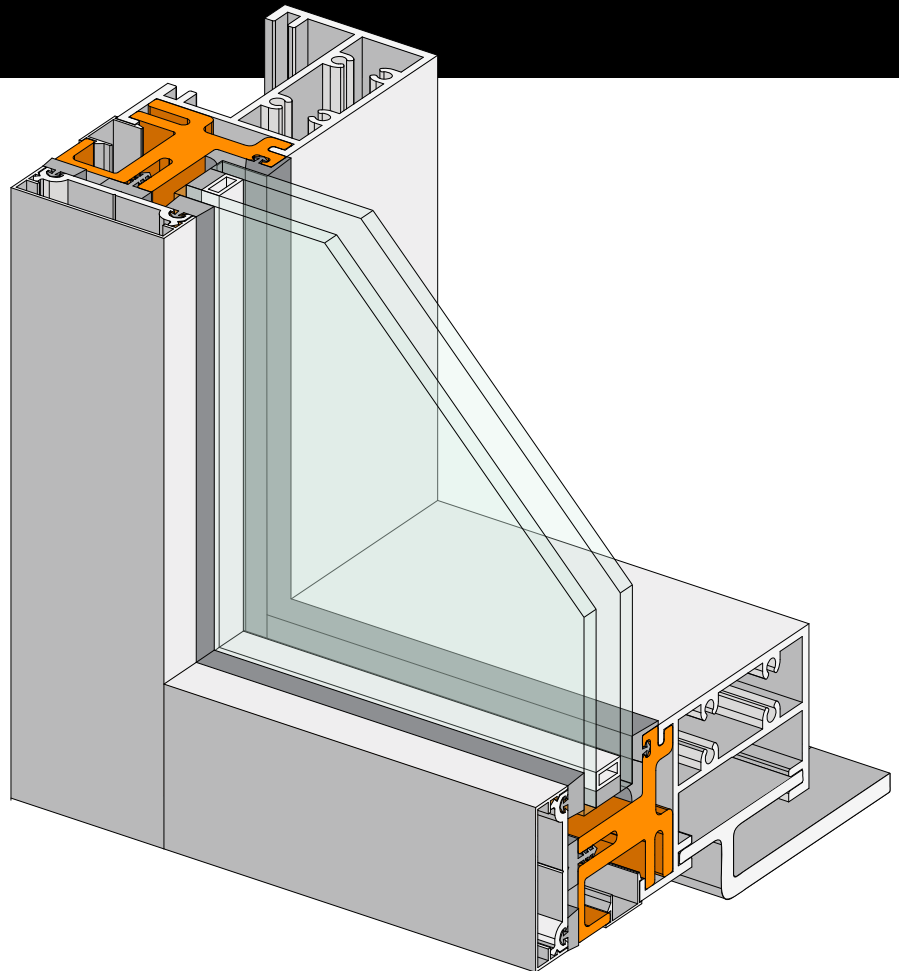

RELATED PROJECT

2465 Van Ness
San Francisco, CA
Handel Architects

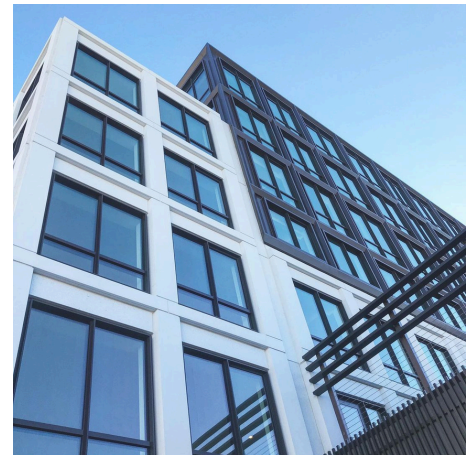

FreMarq
INNOVATIONS

(715) 842-6842

WWW.FREMARQINNOVATIONS.COM



ZERO•NET™

FW2500

HEAD

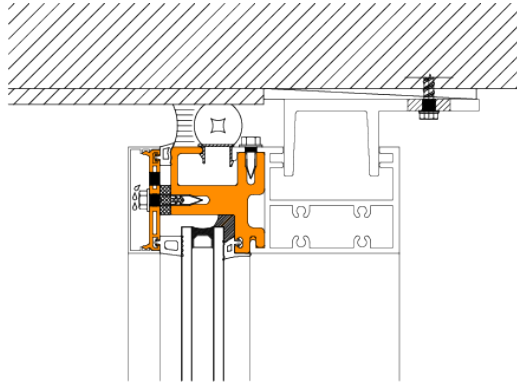

HORIZONTAL

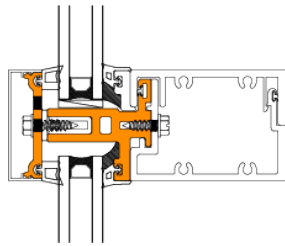

SILL

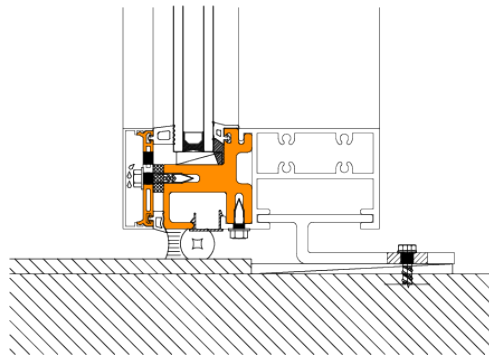

JAMB

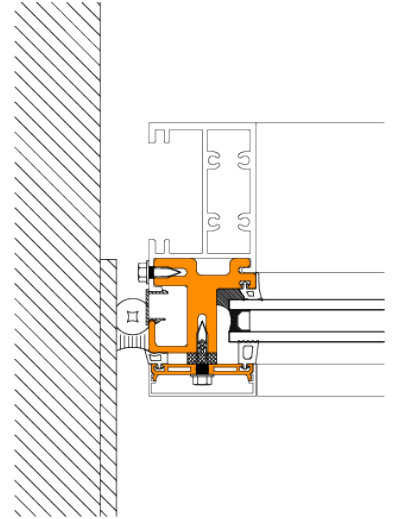

VERTICAL

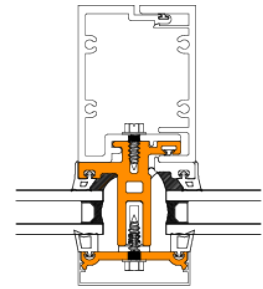

THERMAL PERFORMANCE

Product	Glass	Center of Glass U-Value	Assembled U-Value	Description
FW2500	1" Single Low E	0.246	0.291	NFRC Size
FW2500	1" Double Low E	0.195	0.25	NFRC Size
FW2500	Triple Single Low E	0.183	0.227	NFRC Size
FW2500	Triple Double Low E	0.135	0.189	NFRC Size
FW2500	VIG	0.048	0.17	NFRC Size